



Anhui Sentai WPC New Material Co.,ltd.

WPC M Decking Installation Guide

(ST03A、ST03B)



WEAR WELL WPC is a new type of composites made by mixed bamboo/wood powder with HDPE and other chemical additives which are extruded from the unique high pressure and temperature machine. Because containing of nature fiber, our wear well WPC not only has high degree of anti-UV and weather resistant but also easy to machine. The WPC has the character of highly resistant to moisture and termites, no rotten, no cracking, and color stability, so it will take place of wood decking and plastic decking and will be wildly used in the outdoor.

Our WPC is a safe, environmentally responsible alternative new material which doesn't need painting and glue for its special manufacturing technique and characters. The main material bamboo/wood powder is scrap from decking factory or furnish factory, and another material is recycling plastic. It will save larger number of nature wood and reduce white pollution of using of plastic to protect environment.

To ensure continued client satisfaction, we always buy the good quality raw material. Each piece is knot free and consistent in size, color and length, therefore eliminating the search for the perfect piece. The nature bamboo/wood powder is brought from professional factory and the plastic raw material is the I level recycling plastic which is brought from appointed factory in domestic.

Anhui Sentai WPC New Material Co.,Ltd.

WPC M Decking Installation Guide

(ST03A、ST03B)

Attention before installation:

The method of installation is very important to the products, wrong installation may cause less durability or broken of the products, especially there are 4 points need your serious attention as following:

1. In the joint of 2 deck boards, there must be 2 keels instead of one(each end of the board must have one keel as a support):



2. The gap between 2 boards should be around 30-40cm; gap more than 40cm is not suggested
3. The length of the board is better to be around 2.2-3.6m, too short or too long is not suggested
4. The end of the deck board should be covered by “L” shape corner cover.



Anhui Sentai WPC New Material Co., Ltd.

SenTai WPC Grooved Decking Installation Guide

〈ST01A、ST01B、ST01C、ST01D、ST01F、ST01J、ST05A〉

Prior to installing of any form of decking, it is recommended that you check the local building codes for any special requirements or restrictions and make the floor dry, clean and leveled. Please ask professional builder to install. SenTai WPC M decking should not be used for columns, beams, joists, support posts or other loading bearing segments.

Failure to follow instructions will void the warranty.

Tools:

Electric drill is a must for drilling holes to screw in both the WPC keels & the decking. WPC material does not allow direct screwing by hammer or other heavy tools; otherwise it might be broken by heavy attack.

Standard wood working tools maybe used to cut the board or keels. Gloves might be needed up to installing people's option.

Our stainless screw is recommended, while other standard deck screws/nails can be used also. 1 square meter needs about 29pcs standard stainless nails at most. Because our M decking has tongue at each side for fixing, the quantity of screws can be determined by builder.

Drainage

Its water absorption rate is about 0.2%, expansion/contraction rate is about 0.5%, so a gapping about 2mm between two boards is suggested for future expansion/contraction. (See pics as below)

Slightly slope the decking (5 mm per meter) away from the house to allow for water run-off. When installing a decking over a living space, proper flashing is essential.



Anhui Sentai WPC New Material Co.,ltd.

WPC M Decking Installation Guide

(ST03A、ST03B)

Main parts

M decking (see Pic 1)

Specification: (Width) 15cmx(Height)2.3cmx(Length) which ever

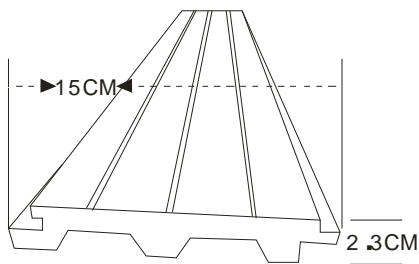

Pic 1

Keels (see Pic 2)

Specification: (Width) 5.0cm x 2.8(Height) cm x(Length) which ever

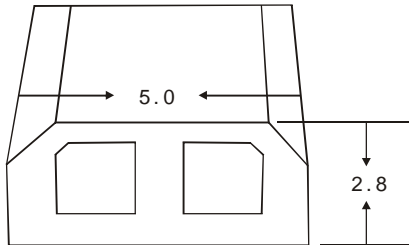

Pic 2

Stainless screw (4X30mm see Pic 3)

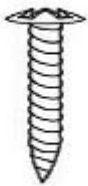

Pic 3

Stainless fitting (90X20mm see Pic 4)

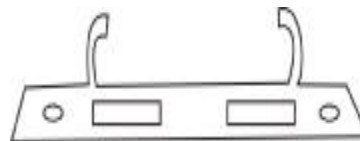

Pic 4

Corner cover (40X40mm see Pic 5)

Side cover (50X4mm see Pic 6)

Side cover (71X17mm see Pic 7)

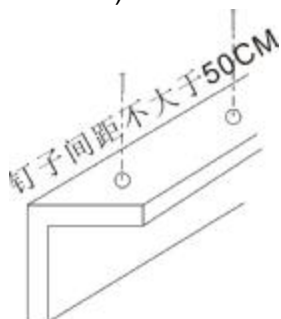

Pic 5

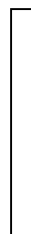

Pic 6

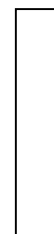

Pic 7

Installation steps

First step: Fix the keels/joist. Arrange the keels equably on the concrete flooring. We suggest there is 30cm distance between each keel. There should be 5mm distance between connecting of keels to avoid expanse (see pic 9). Consider different condition, we suggest some installation method for your reference:

- 1) Drill holes which should be smaller than the diameter of the screw on the keels with electric drill, then fix the keels to the concrete floor with inflation nails. Please do not leave the nail/screw heads above the top surface; otherwise it will make the surface of WPC jagged. (See pic8)
- 2) Stick the keels on the concrete floor with glue, and then fill the half of interval of keel with cement.
- 3) Put the stainless fitting on the keel for 3pcs per meter, and then fix the keel with nails. It is better to protect the edge of keel with cement. This method is much better than 1) and 2) (see pic 10)

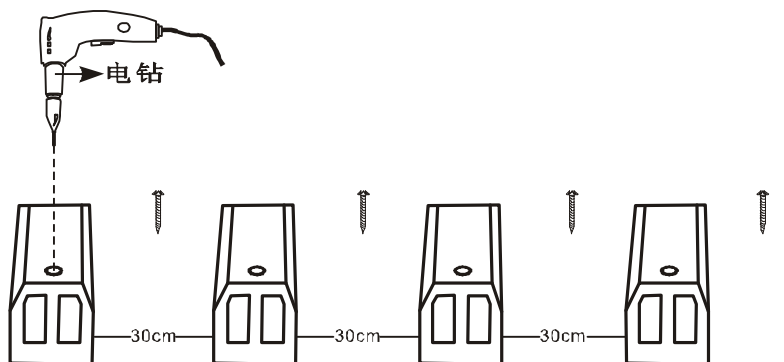

Pic 8

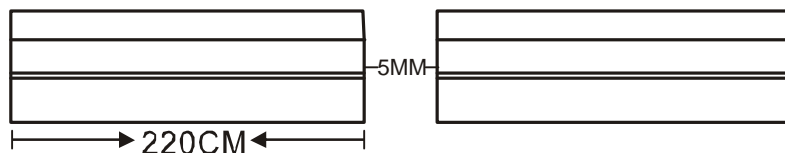

Pic 9

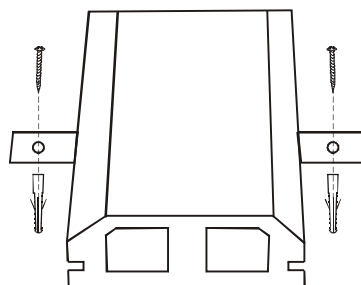

Pic 10

Anhui Sentai WPC New Material Co.,ltd.

WPC M Decking Installation Guide

(ST03A、ST03B)

Second step: fix the first M decking

In order to reach a uniform finish of your entire floor, when installing the first M decking, you can remove the outside tongue by carpenter tools, drill the decking and fix the nail. Or use our corner trim to cover the tongue, drill the decking and fix the nail which can picture frame your deck. After that, drill the inside tongue by electric drill and fix the nail on the keel.

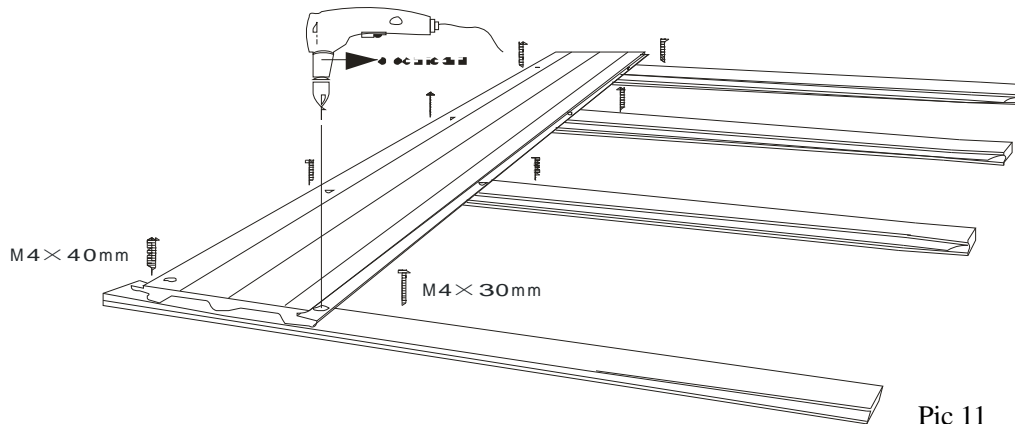

Pic 11

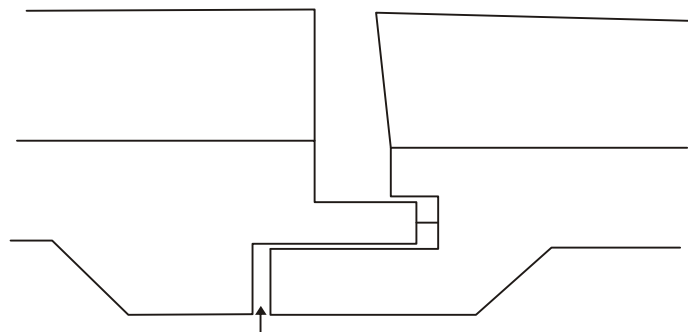

Pic 12

重要提示:此处应间隔2毫米,以防膨胀

Attention: please keep 2mm distance to avoid expanse.

Anhui Sentai WPC New Material Co.,Ltd.

WPC M Decking Installation Guide

(ST03A、ST03B)

Keep 5mm distance at this place

此处间隔5MM

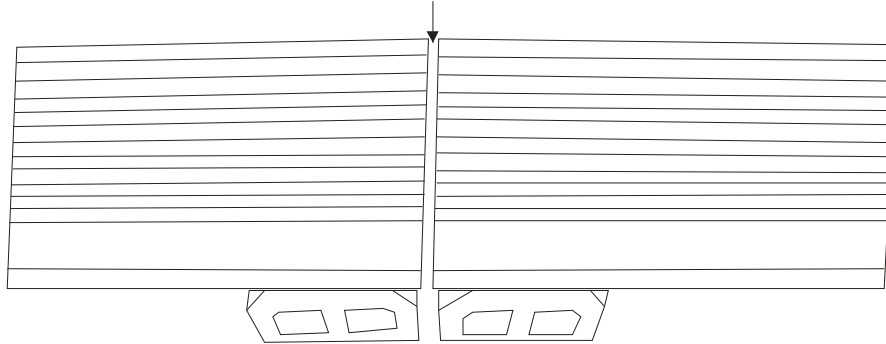

接头处需要放置两根龙骨

Pic 13

Please install 2 keels at the connection

Third step: Fix the second “M” decking

Click the tongue of the second “M” flooring to the groove of the first “M” flooring. Then drill holes by an electric drill on the groove side of the second deck for screwing in nails to fix the deck to the keels. The third and all of the rest decking should be installed according to the second “M” flooring. In this way, all of the decking will fix to each other very firmly.

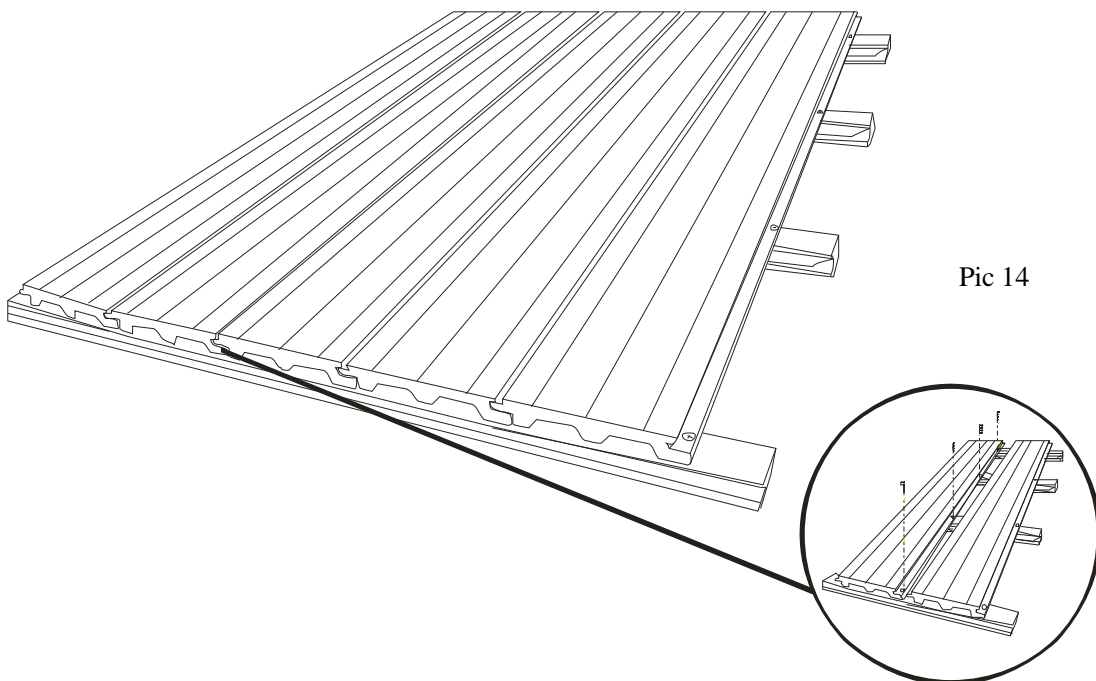

Pic 14



Anhui Sentai WPC New Material Co.,Ltd.

WPC M Decking Installation Guide

(ST03A、ST03B)

Curve Solution

SenTai WPC outdoor decking can not only be installed in a straight road, but also can be installed in a curve, you can cut each piece into a wanted angle, and then place on the curve as per your demand.

Following there are two curve examples:





Anhui Sentai WPC New Material Co.,Ltd.

WPC M Decking Installation Guide

(ST03A、ST03B)

Cleaning

Possible questions	Solutions suggested
Dirt or debris	Clean the decking to remove dirt or debris by using soap, hot water and a stiff bristle.
Mold	Use conventional wood washes or cleaners that contain bleach and detergent (refer to Mold Technical Bulletin).
Chalk Markings	All colored chalk lines are permanent except white. Scrubbing the area with hot soapy water with bleach may dislodge some of the chalk
Ice and Snow	Calcium chloride or rock salt, available in many home centers, will melt ice on decking. Rinse off when first practical.
Rust Stains, Ground-In Dirt and Grime	Use a cleaning product containing oxalic or phosphoric acid base to lighten or remove the rust or dirt. Product may need to sit on stain 10-15 minutes.
Oil and Grease Stains	Scrub in a household-degreasing agent as soon as the stain occurs. Rinse with hot water.
Berries and Wine Stains	Mix bleach into hot water according to the bleach-packaging label. Scrub the stain lightly and rinse thoroughly. The stain may not disappear entirely.
Ink Stains	Inks may be permanent. However, scrubbing with hot soapy water may lighten the stain. Rinse thoroughly.

Note: Periodic cleaning of SenTai WPC decking is suggested, even if it appears clean, is important to prevent the build-up of pollen/debris that can cause mold. If unsure about the product being used to clean/remove stains from your deck, it is recommended that you test a small area in an inconspicuous place to determine if the product will cause any unwanted discoloration. Using a spray nozzle may use commercial pressure washers to remove stains, ground in dirt, or mold.



Anhui Sentai WPC New Material Co.,Ltd.

WPC M Decking Installation Guide

(ST03A、ST03B)

Color Variations:

Although we have already added colorants and stabilizers during production, the decking will still have slight color variations. This is a natural occurrence in the fibers and plastic used in the manufacturing process

Due to variations in the manufacture runs, it is recommended that all required composite decking materials be purchased at the same time and an allowance for coverage is recommended. SenTai decking will lighten over time and color variation are not covered under the warranty

Limited Warranty:

SenTai WPC decking comes with a 15-year limited warranty, which should be under proper usage that provides comprehensive coverage against splintering, splitting, rot or decay, and in termite damage. Our products have been tested by China's government organization, which issued a formal TEST REPORT for our products quality. We can provide this TEST REPORT copy if it is needed.

Attention:

Wood Plastic Composites has many good features in outdoor usage, while it also has some shortages. The most evident shortage is its IMPACT RESISTANCE is not very good, this is decided by inside structure of this material.

Here is our recommendation:

Please try to keep this material away from heavy impact or attack during usage.

Please take care of it during transportation, installation and storage, avoid its falling from high place.

For more information and customer service please call 0086-0572-2127866 or email to hzshentai@vip.163.com.

Website: www.sentai-wpc.com

Contact person Susan Yang.